

MD-1214

STANDARD FEATURES

- Designed for Breaking Strength of 1-1/4" (32 mm) EIPS Wire Rope, 159,800 LBS, with 90° Wrap on the Sheave
- Cast Steel Sheave with Hardened Rope Groove for Longer Life
- Grease Lubricated Bronze Bearings in Sheave
- Weld Down Mounting Base
- Epoxy Primer Coating



OPTIONAL FEATURES

- Customized Design to Suit Your Application
- Multiple Sheaves
- Stainless Steel or Nylon Sheaves
- Sealed Tapered Roller Bearings in Sheave
- Bolt Down Mounting Base
- Load Monitoring System
- Three Coat Marine Paint System
- Third Party Certification

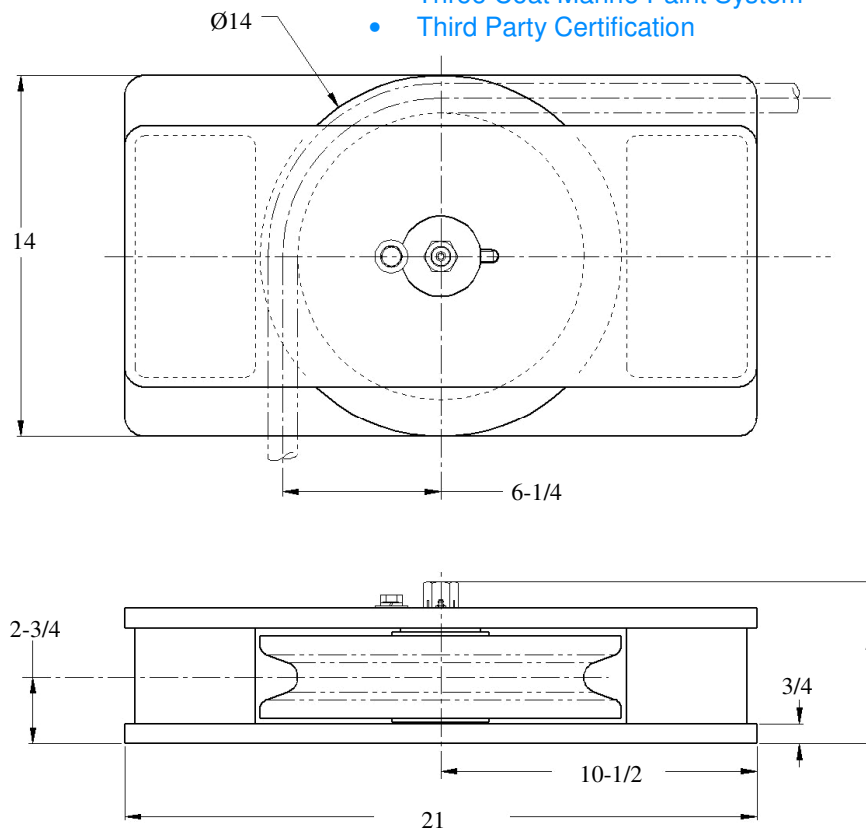

WEIGHT: 200 LBS

* DIMENSIONS SUBJECT TO CHANGE WITHOUT NOTICE*

Smith Berger Marine, Inc. - Mooring & Towing Solutions

7915 10th Ave. S., Seattle, WA 98108 USA

Tel. 206.764.4650 - Toll Free 888.726.1688 - Fax 206.764.4653

E-mail: sales@smithberger.com - Web: www.smithberger.com